

ALGIZ RT8

MANUAL



handheld

CONTENT

1. Introduction	3
1.1 Appearance of Algiz RT8	3
1.2 Installing the Battery	4
1.3 Removing the Battery	5
1.4 Installing a SIM card	6
1.5 Installing a micro-SD card.....	7
2. Pogo pin definition.....	8
3. Enabling/disabling glove mode	9
4. Open/Close HDMI	10
5. Function keys	11

1. INTRODUCTION

1.1 Appearance of Algiz RT8

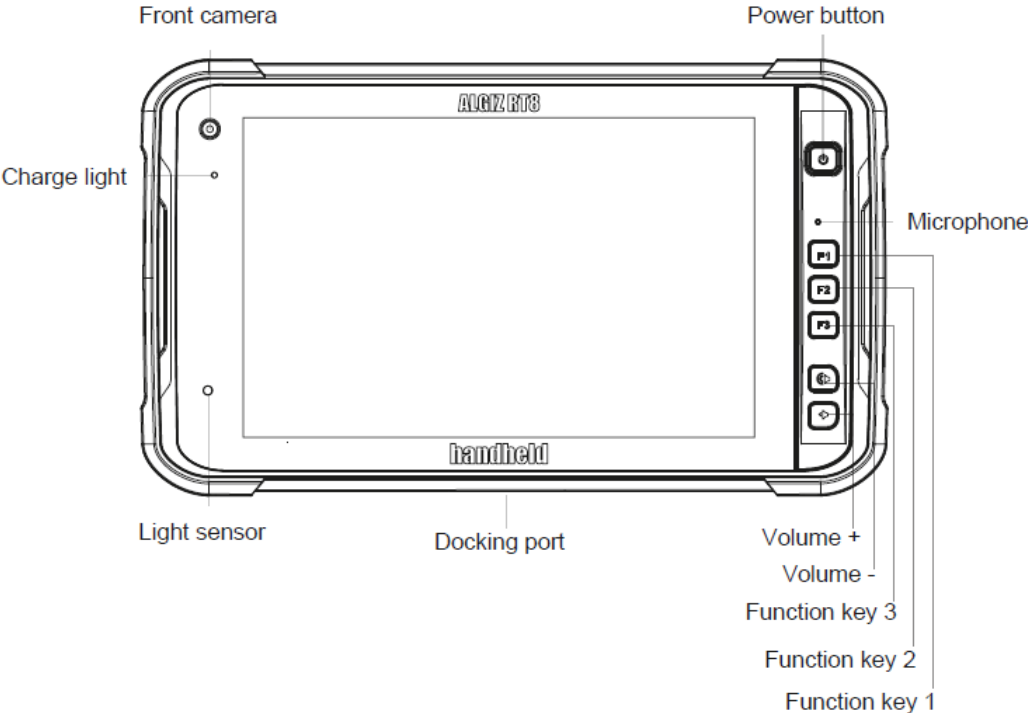

FIGURE 1-1 FRONT VIEW OF ALGIZ RT8

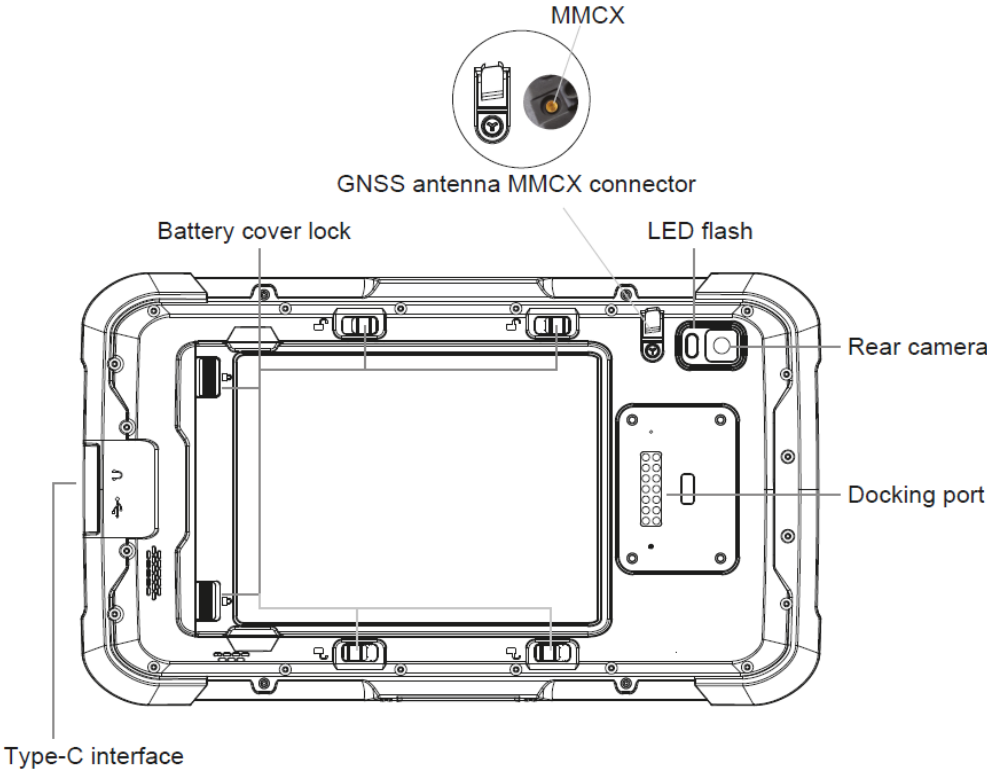
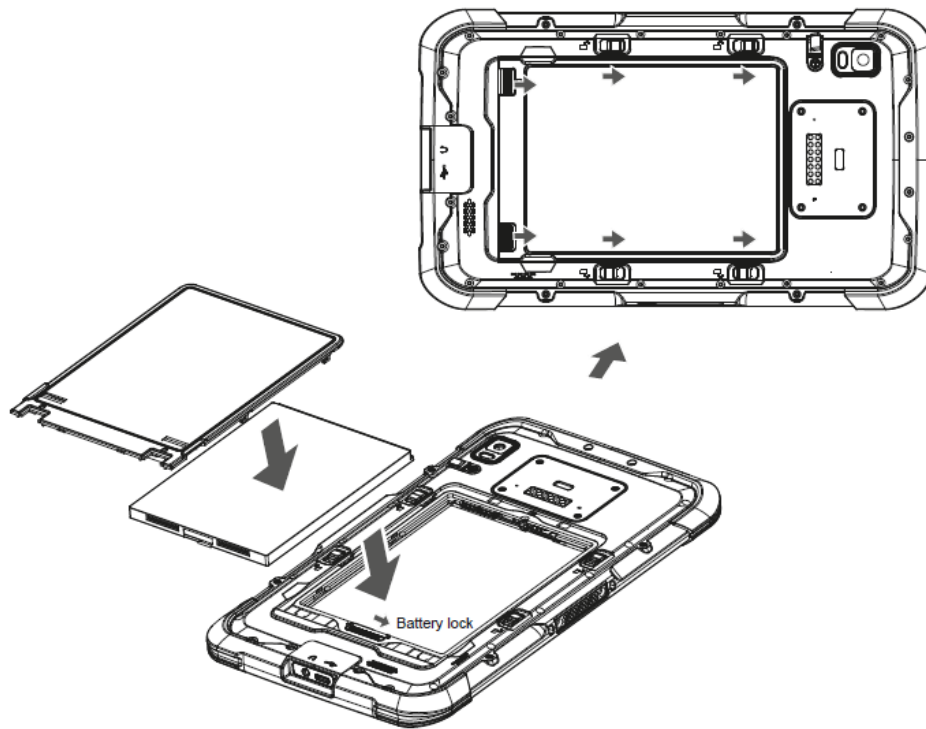

FIGURE 1-2 SIDE VIEW OF ALGIZ RT8

1.2 Installing the Battery

1. Insert the battery
2. Push the battery lock to the close position
3. Attach the battery cover
4. Push the battery cover lock to the close position



1.3 Removing the Battery

1. Power off the device before removing the battery
2. Push the battery cover lock to the open position
3. Detach the battery cover
4. Push the battery lock to the open position
5. Remove the battery

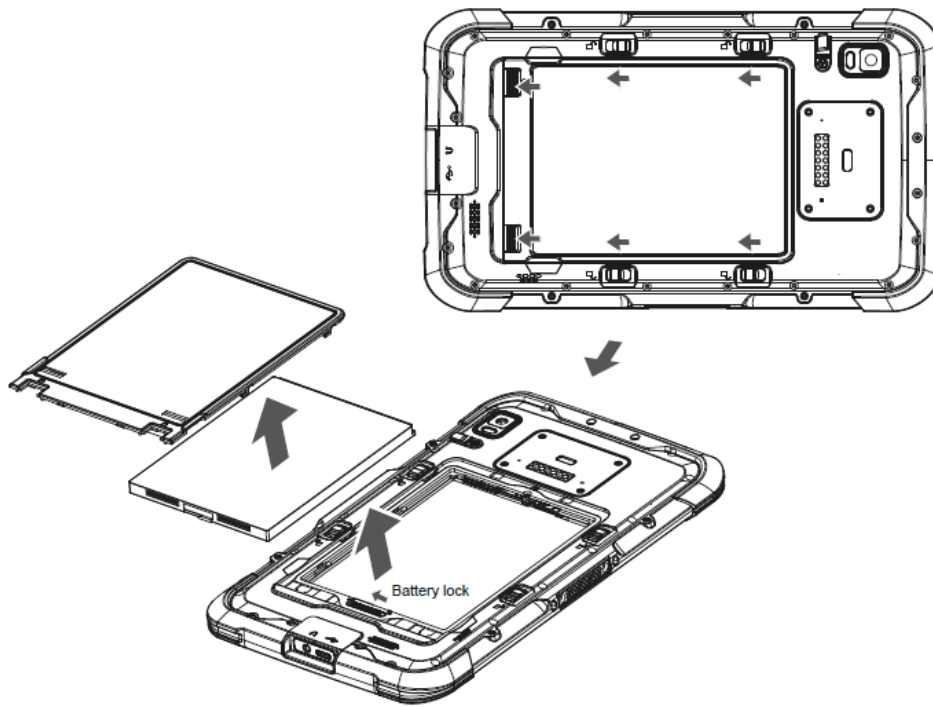

1.4 Installing a SIM card

This is how you insert and remove the Nano SIM/micro SD.

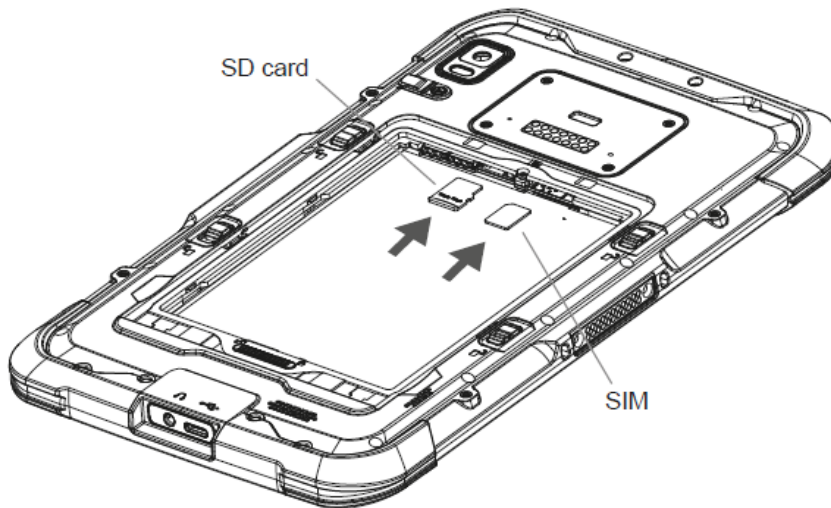

1.5 Installing a micro-SD card

This is how you insert and remove the Nano SIM/micro SD.

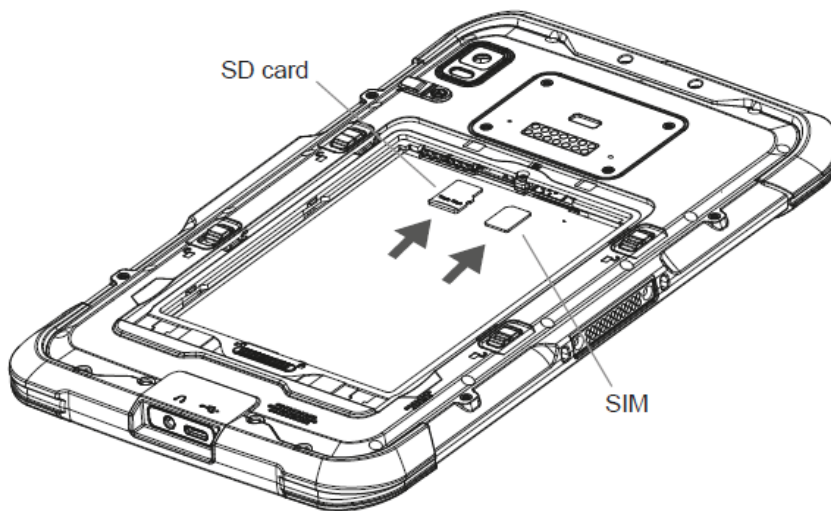

2. POGO PIN DEFINITION

Back pogo pin

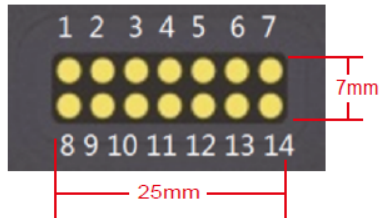

1	GND	Ground PIN	8	UART_RX	1.8V UART RXD
2	GND	Ground PIN	9	UART_TX	1.8V UART TXD
3	USB_DM	USB 2.0 bus Data -	10	GPIO_1	1.8V GPIO 1
4	USB_DP	USB 2.0 bus Data +	11	GPIO_2	1.8V GPIO 2
5	USB_ID	USB 2.0 OTG ID PIN	12	IRQ	1.8V External Interrupt PIN
6	V_BUS	5V/500mA Power OUT (OFF default)	13	NA	NA
7	V_OUT	3.8V/500mA Power OUT (OFF default)	14	V_BAT_IN	4.2V/2A Power In Warning: V_BAT_IN power supply must be in the case of no battery.

Bottom pogo pin

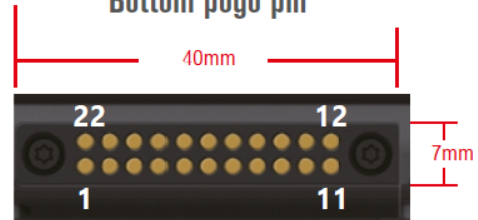

PIN	22pin定义
1	GND
2	TMDS Clock-
3	TMDS Clock+
4	TMDS D0-
5	TMDS D0+
6	GND
7	TMDS D1-
8	TMDS D1+
9	TMDS D2-
10	TMDS D2+
11	GND
12	GND
13	USB D-
14	USB D+
15	IRQ
16	DDC I2C_SDA
17	DDC I2C_SCL
18	CEC
19	HPD
20	HDMI 5V
21	USB VBUS
22	GND

3. ENABLING/DISABLING GLOVE MODE

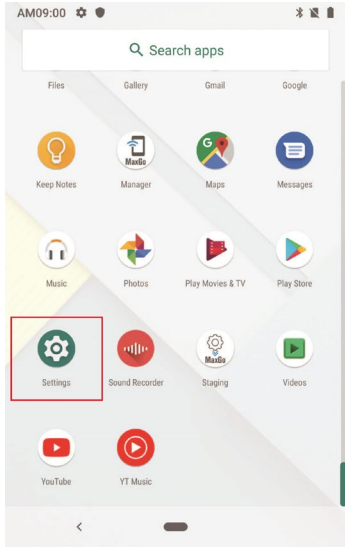

FIGURE 1

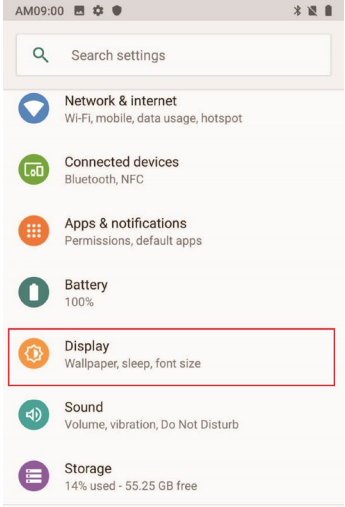

FIGURE 2

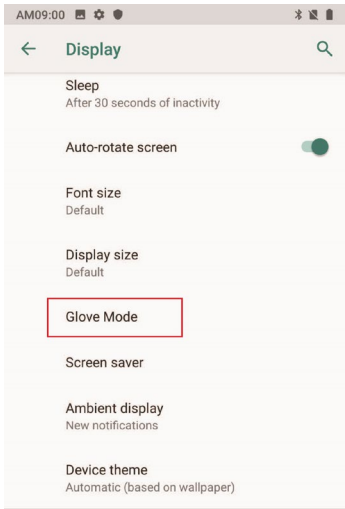

FIGURE 3

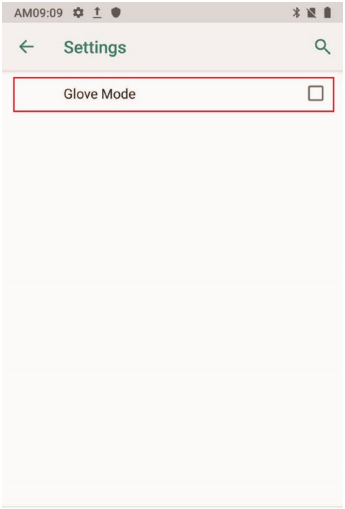

FIGURE 4

4. OPEN/CLOSE HDMI

If you have purchased the desktop dock accessory and plan on using an external HDMI display, you need to make sure to enable the HDMI function per below:

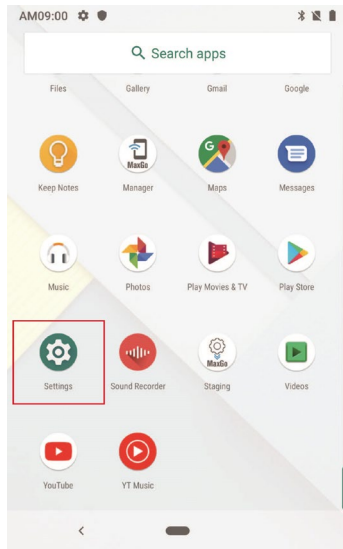

FIGURE 1

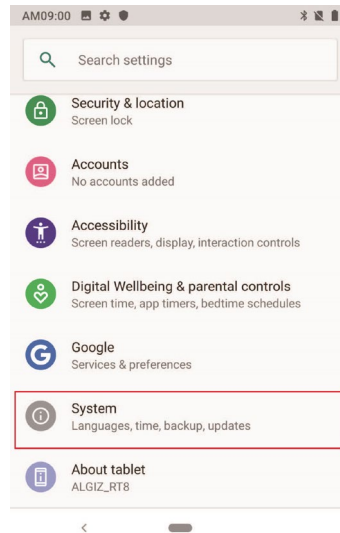

FIGURE 2

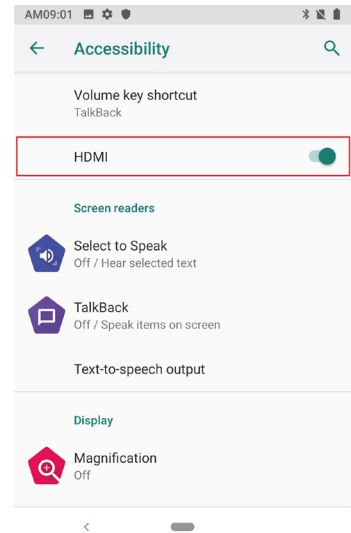

FIGURE 3

5. FUNCTION KEYS

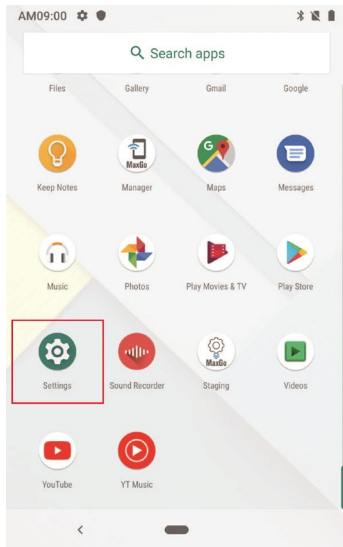

FIGURE 1

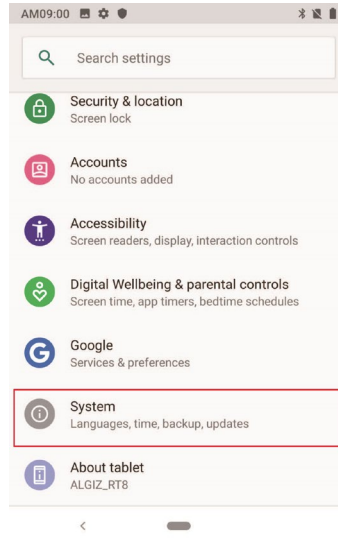

FIGURE 2

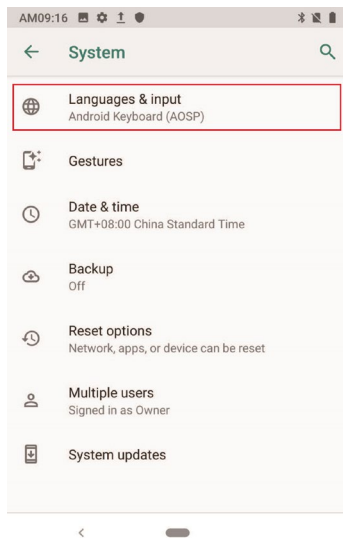

FIGURE 3

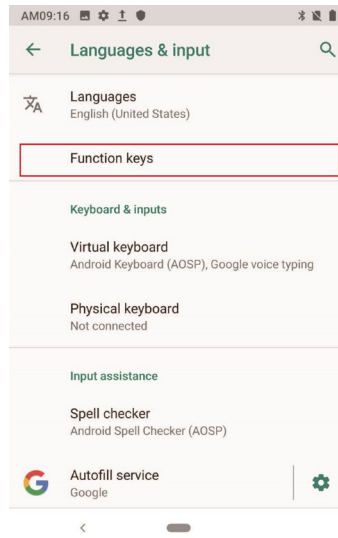

FIGURE 4

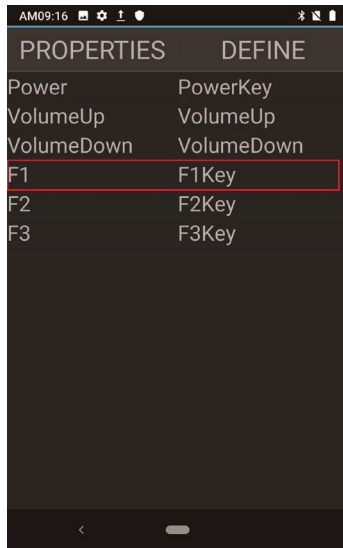

FIGURE 5

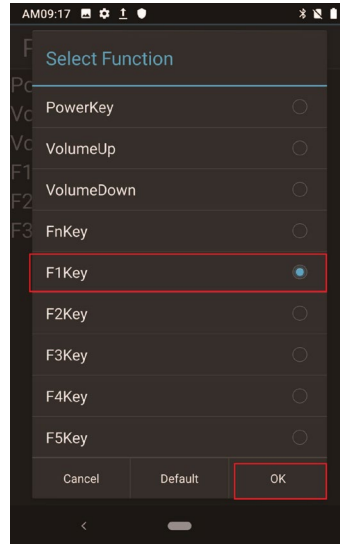

FIGURE 6

NOTICE:

The SAR limit of Europe is 2.0 W/kg. Device types ALGIZ RT8 has also been tested against this SAR limit. The highest SAR value reported under this standard during product certification for use on the body is 0.0843W/kg. This device was tested for typical body - worn operations with the back of the handset kept 0 cm from the body. To maintain compliance with RF exposure requirements, use accessories that maintain a 0 cm separation distance between the user's body and the back of the handset. The use of belt clips, holsters and similar accessories should not contain metallic components in its assembly. The use of accessories that do not satisfy these requirements may not comply with RF exposure requirements and should be avoided.

Working Temperature: -20°C ~ +55°C

Storage Temperature: -40°C ~ +70°C

Charging mode need to operate indoors, please pay attention to the environment temperature should be 0°C ~ +45°C

CAUTION RISK OF EXPLOSION IF BATTERY IS REPLACED BY AN INCORRECT TYPE. DISPOSE OF USED BATTERIES ACCORDING TO THE INSTRUCTIONS

Hereby, [Handheld Group AB] declares that the radio equipment type.

[ALGIZ RT8] is in compliance with Directive 2014 / 53 /EU.

The full text of the EU declaration of conformity is available at the following internet address:

www.handheldgroup.com

This device complies with Part 22 & 24 and Part 27 of the FCC Rules.

SAR INFORMATION

The SAR limit of FCC and ISED is 1.6 W/kg averaged over one gram of tissue. Device types ALGIZ RT8 (FCC ID:YY3-118208 and IC: 11695A-118208) has also been tested against this SAR limit. The highest SAR value reported under this standard during product certification for use on the body is 0.939W/kg. This device was tested for typical body -worn operations with the back of the handset kept 0 cm from the body. To maintain compliance with FCC and ISED RF exposure requirements, use accessories that maintain a 0 cm separation distance between the user's body and the back of the handset. The use of belt clips, holsters and similar accessories should not contain metallic components in its assembly. The use of accessories that do not satisfy these requirements may not comply with FCC and ISED RF exposure requirements and should be avoided.

NOTICE:

This device complies with Part 15 of the FCC Rules and with RSS-210 of Industry Canada. Operation is subject to the following two conditions:

(1) this device may not cause harmful interference, and

(2) this device must accept any interference received, including interference that may cause undesired operation.

Le présent appareil est conforme aux CNR d'Industrie Canada applicables aux appareils radio exempts de licence. L'exploitation est autorisée aux deux conditions suivantes : (1) l'appareil ne doit pas produire de brouillage, et (2) l'utilisateur de l'appareil doit accepter tout brouillage radioélectrique subi, même si le brouillage est susceptible d'en compromettre le fonctionnement.

NOTICE:

Changes or modifications made to this equipment not expressly approved by Handheld Group AB may void the FCC authorization to operate this equipment.

NOTE: This equipment has been tested and found to comply with the limits for a Class B digital device, pursuant to Part 15 of the FCC Rules. These limits are designed to provide reasonable protection against harmful interference in a residential installation. This equipment generates, uses and can radiate radio frequency energy and, if not installed and used in accordance with the instructions, may cause harmful interference to radio communications. However, there is no guarantee that interference will not occur in a particular installation. If this equipment does cause harmful interference to radio or television reception, which can be determined by turning the equipment off and on, the user is encouraged to try to correct the interference by one or more of the following measures:

Reorient or relocate the receiving antenna.

Increase the separation between the equipment and receiver.

Connect the equipment into an outlet on a circuit different from that to which the receiver is connected.

Consult the dealer or an experienced radio/TV technician for help.

NOTICE:

This Class [B] digital apparatus complies with Canadian ICES -003.

Cet appareil numérique de la classe [B] est conforme à la norme NMB - 003 du Canada.

RF mode and power tune-up refer to appendix A

Antenna Type

FPC Antenna

Power:

GSM/GPRS/EGPRS900:33dBm

GSM/GPRS/EGPRS1800:30dBm

WCDMA/HSDPA/HSUPA Band 1:22.5dBm

WCDMA/HSDPA/HSUPA Band 8:23dBm

LTE FDD Band 1:22.5dBm , LTE FDD Band 3:23dBm , LTE FDD Band 7:23dBm , LTE FDD

Band 8:23.5dBm,LTE FDD Band 20:23dBm , LTE FDD Band 28:23dBm , LTE TDD Band38:

22.5dBm , LTE TDD Band 40: 23dBm

GSM Release 99 ;WCDMA Release 6 ;LTE Release 8

WIFI and BT 2400-2483.5MHz : 14 dBm

WIFI(5150-5250MHz): 12dBm

WIFI(5725-5850MHz) : Power:11dBm ,Receiver category:2

NFC : 13.56MHz/ Power class 4 / Modulation type: ASK / antenna gain : 0dBi

GPS :1559-1610MHz

GSM900 (880.2MHz---914.8MHz)

DCS1800 (1710.2MHz---1784.8MHz)

WCDMA band 1 (1922.4MHz---1977.6MHz)

WCDMA band 8 (1712.4MHz---1782.6MHz)

LTE BAND 1 (1922.5---1977.5)MHz

LTE BAND 3 (1710.7---1784.3)MHz

LTE BAND 7 (2502.5---2567.5)MHz

LTE BAND 8 (880.7---914.3)MHz

LTE BAND 20 (834.5---859.5)MHz

LTE BAND 28 (704.5---746.5)MHz

LTE BAND 38 (2572.5---2617.5)MHz

LTE BAND 40 (2302.5---2397.5)MHz